

Wilkhahn

OCCO. 222 range.





Occo.

Occo's forte is its diverse range of models for different scenarios with the same design language throughout. Four frames, three types of cushioning and six shell colours produce a total of 72 variants which, along with different table shapes and table tops, respond to virtually all functional and design requirements. Occo is at home in canteens to informal places for meet-ups to high-quality conference rooms. The seat shell and its characteristic cut-out section at the back, plus the different material thicknesses, ensure unusual comfort. With the four-leg chrome-plated metal frame up to ten of them can even be stacked on top of one another.





OCCO. 222 range. Technical details.

Wilkhahn



Design: jehs+laub

Function

In conference rooms, open-plan meeting areas or company restaurants: Occo offers superior comfort, enormous versatility and a vast range of design options in a distinctive design language.

Chairs

Frame

Four-leg frame models 222/10, 222/11, 222/12

Tubular steel frame with textured matt finish coated in white, black, grey, grey-beige, orange-red, blue-grey or bright chrome-plated.

Please note: Coated frame versions are not stackable.

Model 222/10 (shell not upholstered) with four separators made of PUR and frame cover made of plastic (PP) each in dark grey. Models 222/11 and 222/12 with stacking guard made of plastic (PP) in dark grey.

Four-leg frame in solid wood models 222/20, 222/21, 222/22

Seat bearer made of tubular steel in dark grey with a textured matt finish to fit onto the seat shell and to attach the four legs made of solid oak with a natural oiled finish.

Four-star base models 222/30, 222/31, 222/32, five-star base models 222/40, 222/41, 222/42

Butted tubular steel with a textured matt finish coated in white, black, grey, grey-beige, orange-red, blue-grey or bright chrome-plated with seat bearer made of moulded flat steel in dark grey with a textured matt finish to attach to the shell. In the case of four-star bases, the steel glides are in dark grey with a textured matt finish. Four-leg and four-star base models are fitted with multipurpose glides for soft and hard floorings. For sensitive flooring, please order with extra felt glides (at no additional charge). Five-star base models 222/40, 222/41, 222/42 with twin wheel swivel castors with load-dependent braking, made of black polypropylene compliant with DIN EN 12529 as the standard version for carpets, optionally with grey polyurethane tyre for hard floors.

Seat and backrest

Unitary, ergonomically moulded seat shell with cut-out section, made of reinforced through-dyed polypropylene optionally in white, black, grey, grey-beige, orange-red or blue-grey.

Models 222/10, 222/20, 222/30, 222/40 optionally with felt seat cushion with anti-slip coating. In anthracite, light mottled, graphite, mango, verde, deep water. Models 222/11, 222/21, 222/31, 222/41, with seat cushion and models 222/12, 222/22, 222/32, 222/42 with padding on the inside made of cut foam in each case.

Standards

The multipurpose Occo chairs with four-leg frames comply with the DIN EN 16139-L1 office chair standard.



www.tuv.com
ID 100000000

Please note

To ensure quality is maintained we do not offer white leather (74/72). All other standard leather colours are possible. When exposed to ultra violet rays for long periods of time, the colours of plastics can change slightly. Due to the nature of the material, there are slight differences in the colour between white table tops with bonded surfaces and HPL table tops and the white Occo plastic chairs.

OCCO. 222 range. Technical details.

Wilkhahn

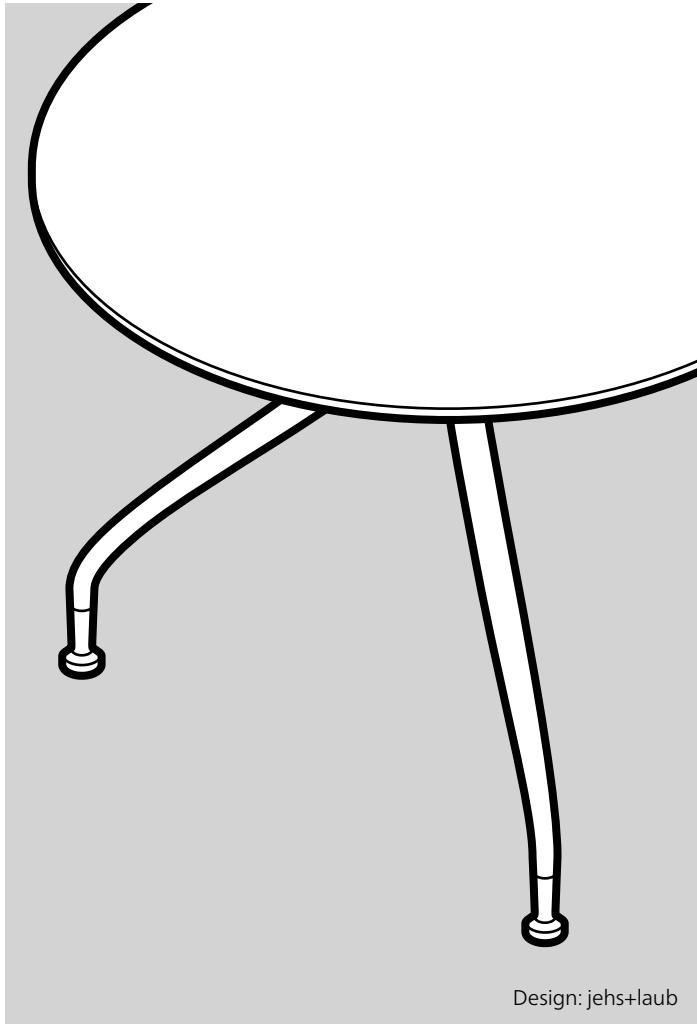

Design: jehs+laub

Tables

Frame

Models 222/60 and 222/70 with four star-shaped table legs made of butted tubular steel, optionally with a textured matt finish coated black or white or bright chrome-plated. Models 222/80 and 222/90, table legs connected with a cross-beam. Models as of 90 x 180 incl. extra reinforcement uprights in dark grey textured matt finish. All table top bearers and glides made of steel in dark grey with a textured matt finish. All tables are fitted with multipurpose glides for soft and hard floorings. In the case of wooden floorings (e.g. parquet) please order with extra felt glides (at no additional charge). Adjustment range: 10 mm. Optionally with lockable, height-adjustable, swivel castors with a black polyamide tyre as the standard version for carpeted floors; castors available with a polyurethane tyre for hard floors (please specify when ordering).

Core panels on table top, table top group 2 – veneer variation 1 and 2

MDF (medium density fibreboard), table top thickness 26 mm Variant 1: Beech, oak or ash veneer from Wilkhahn woodstain colour samples with chamfered wood lipping (exception: not in natural ash), colour matched as far as possible with the veneer Variant 2: Walnut or elm veneers, as well as Wilkhahn Mocca veneer from the Wilkhahn woodstain colour samples with chamfered wood lipping, colour matched as far as possible with the veneer. Table height 74.4 cm

Table top group 5 – with bonded surface

Table top thickness 25 mm thick, melamine resin, with bonded surface in white or black with straight plastic lipping colour matched with the surface. Table height 74.3 cm

Table top group 7 - black/white through-dyed

Tabletop thickness 12 mm. Table top made of through-dyed HPL (High Pressure Laminate) in black or white, chamfered lipping. Table height 73 cm

Table top group 10 – solid wood

Table top thickness 25 mm, solid oak based on the Wilkhahn woodstain colour samples, natural oiled finish, lipping, rounded on the bottom. Table height 74.3 cm

Please note

Due to the nature of the material, there are slight differences in the colour between white table tops with bonded surfaces and HPL table tops and the white Occo plastic chairs.

Edge profiles



E4 – 1 solid wood edge, rounded on the bottom



E2 – 3 Straight plastic edging



E2 – 5 Chamfered wood edging, 12mm

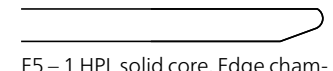

E5 – 1 HPL solid core, Edge chamfered, 4 mm radius

OCCO. 222 range. Product types.

Wilkhahn



222/10 Multipurpose chair
Four-leg frame



222/20 Multipurpose chair
Solid wood four-leg frame



222/30 Multipurpose chair
Four-star base frame



222/40 Multipurpose chair
Five-star base frame on castors

Occo table. 222 range. Product types.

Wilkhahn

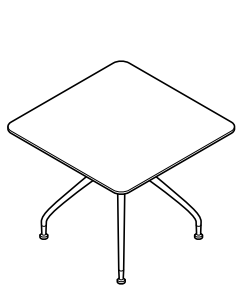

222/60 Square

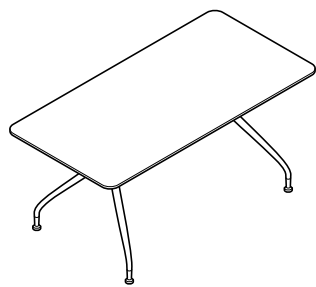

222/80 Rectangular

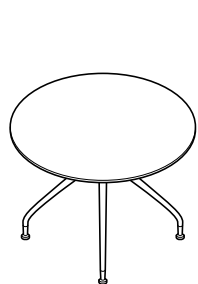

222/70 Round

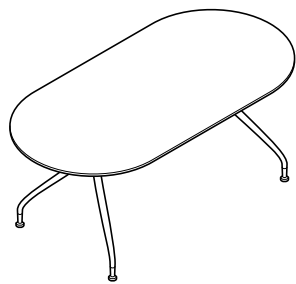

222/90 Oval



OCCO. 222 range. Upholstery types.

Wilkhahn



222/10 Multipurpose chair not upholstered



222/11 Multipurpose chair with seat cushion



222/12 Multipurpose chair with padding on inside



222/10 Multipurpose chair not upholstered with felt cushion

Upholstery material (not all upholstery materials apply to all types)

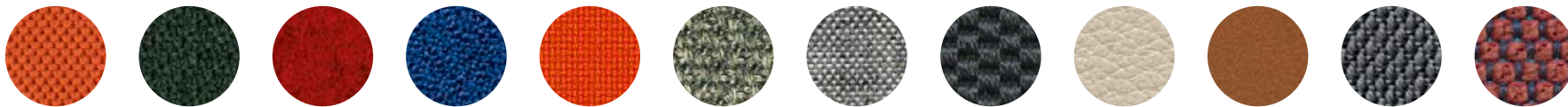

37 | 54 | 60 | 63 | 66 | 67 | 68 | 69 | 74 | 87 | 91 | 92 | You can find all upholstery materials and more colours in our media center.

The digital sample colours differ from the originals.

Occo table. 222 range. Product types.

Wilkhahn



Solid oak table tops, 25 mm thick, edge rounded on the bottom



Black through-dyed HPL (High Pressure Laminate) table tops, 12 mm thick, chamfered edge

Table top groups



Direct coating, through-dyed black/white, veneer version 1 or 2, solid wood, you can find further surfaces in our media center

The digital sample colours differ from the originals.

Edge profiles



Solid wood edge, rounded on the bottom, plastic lipping straight, chamfered wood edge or HPL solid core, chamfered edge

OCCO. 222 range. Frame types.

Wilkhahn



222/10 Multipurpose chair
Frame coated, not stackable



222/10 Multipurpose chair
Bright chrome-plated frame,
stackable



222/30 Multipurpose chair
Frame coated, swivel-mounted,
not stackable



222/30 Multipurpose chair
Bright chrome-plated frame,
swivel-mounted, not stackable



222/40 Multipurpose chair
Frame coated, swivel-mounted,
not stackable



222/40 Multipurpose chair
Bright chrome-plated frame,
swivel-mounted, not stackable



222/20 Multipurpose chair
Solid wood frame, not stackable

Frame surfaces, seat and backrest shell

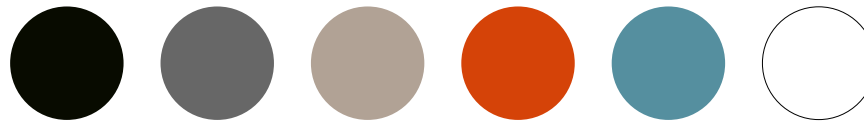

Black, grey, grey-beige, orange-red, blue-grey or white, textured matt finish

The digital sample colours differ from the originals.
You can find our current fabric collection in our media center.

Additional frame surfaces



Bright chrome-plated tubular steel
or solid oak

Occo table. 222 range. Frame types.

Wilkhahn



Bright chrome-plated tubular steel, black or white coated with a textured matt finish

The digital sample colours differ from the originals.
You can find our current fabric collection in our media center.

OCCO. 222 range. Accessories and other items.

Wilkhahn

Felt cushions

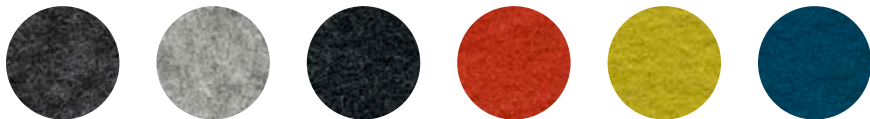

Anthracite, light mottled, graphite, mango, verde, deep water

OCCO. 222 range. Models and dimensions.

Wilkhahn

222/10
Multipurpose chair

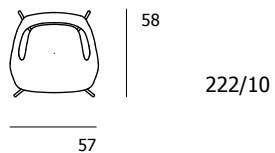
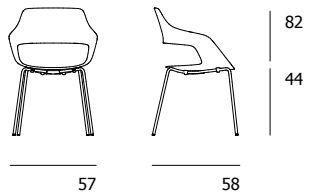

222/11
Multipurpose chair

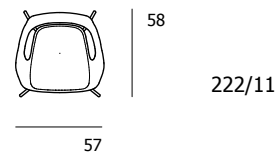
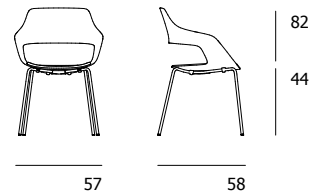

222/12
Multipurpose chair

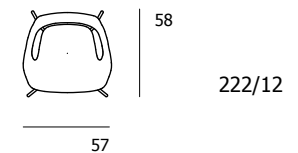
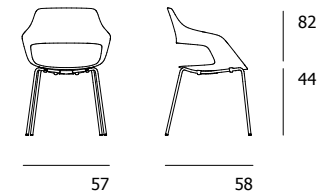

222/20
Multipurpose chair

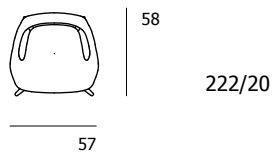
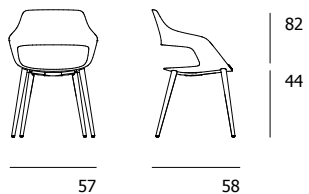

222/21
Multipurpose chair

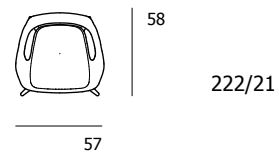
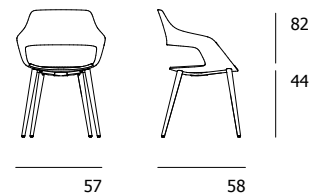

222/22
Multipurpose chair

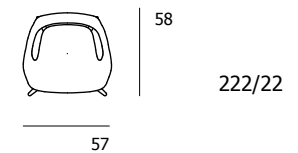
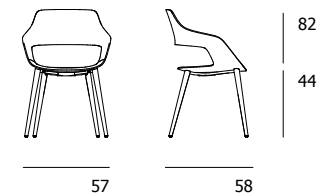

OCCO. 222 range. Models and dimensions.

Wilkhahn

222/30
Multipurpose chair

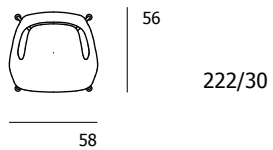
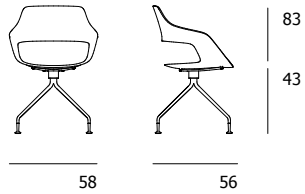

222/31
Multipurpose chair

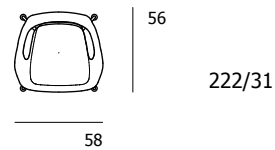
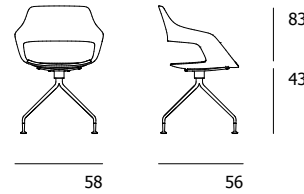

222/32
Multipurpose chair

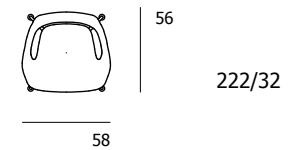
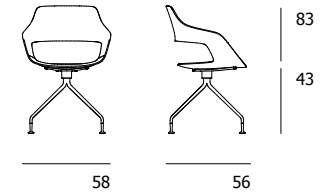

222/40
Multipurpose chair

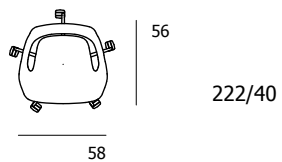
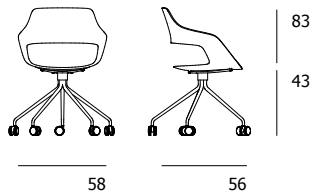
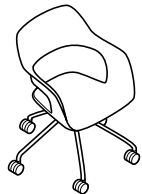

222/41
Multipurpose chair

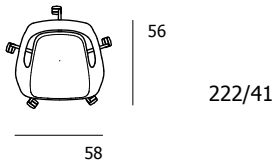
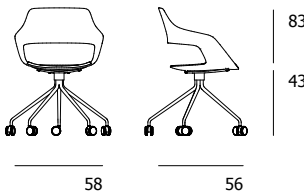

222/42
Multipurpose chair

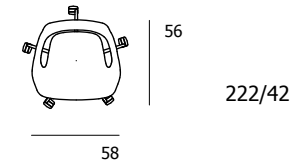
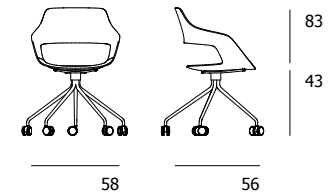

Occo table. 222 range. Models and dimensions.

Wilkhahn

222/60
Square

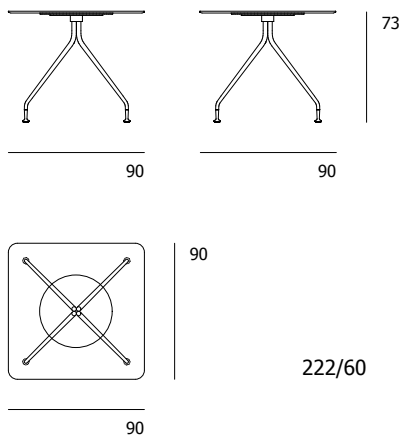
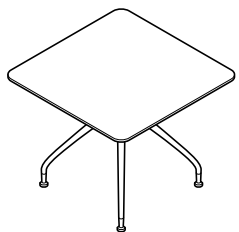

222/70
Round

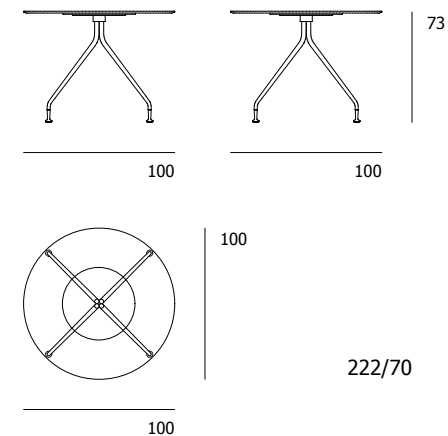
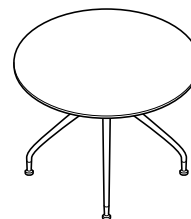

222/80
Rectangular

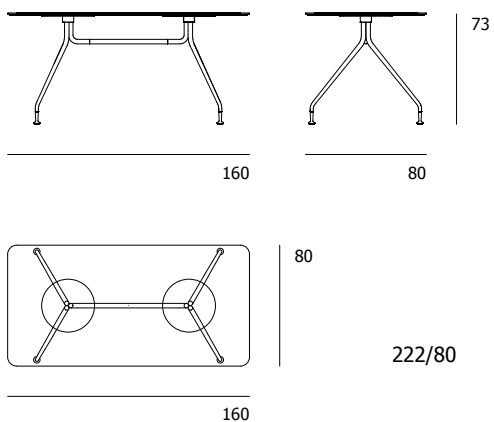
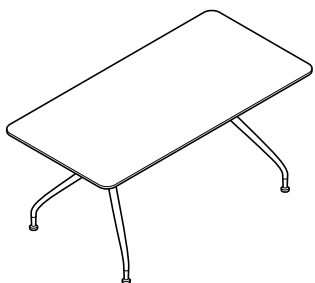

222/90
Oval

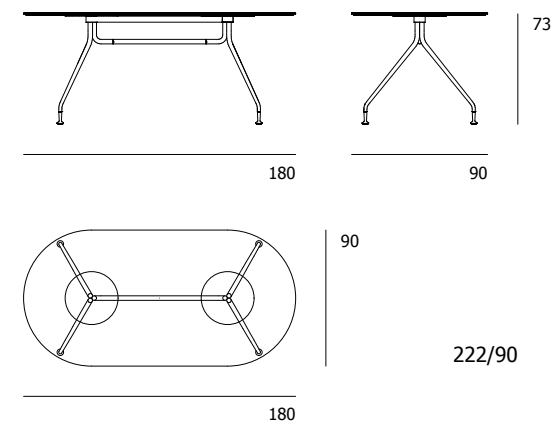
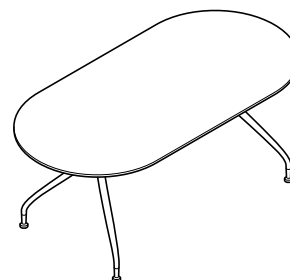

OCCO. 222 range. Awards / standards / certificates.

Wilkhahn

Awards



Product certificates / product standards



Company's certificates, memberships

